

Graypants

Lookbook

Seattle

3220 1st. Ave. S. Suite 400
Seattle, WA 98134
(206) 420-3912
seattle@graypants.com

Amsterdam

Meeuwenlaan 126B,
1021JN Amsterdam
+31 (0) 20 820 8990
amsterdam@graypants.com

 graypants®





Here at Graypants we are a team of problem solvers, designing products, architecture and bold installations with a focus on imagination, natural materials and quality craftsmanship. Through beautiful and practical design, we look to elevate the world around us in ways that can be appreciated for a lifetime. Anchored in Seattle and Amsterdam, our work expands globally including collaborations and custom designs for leading companies worldwide, transforming space with light.

Dream big.
Scribble often.
Make thoughtfully.

Creating a place to gather, Wick is designed to be a companion, to join in adventures and create togetherness and ambiance everywhere. Wick is a call from our past to the future; it's the opportunity to mindfully light the present.

Wick





Wick

Wick is designed with the belief that light is meant to be shared. As a portable LED table lamp, Wick is candlelight for the modern era – safe, versatile, and classic.

Activate Wick using a touch sensor, and toggle between four brightness settings including a gentle, flickering candle mode. Depending on the brightness setting, Wick stays lit from 7 to 70 hours.

Combining the romance of a candle with the utility of a flashlight, Wick is at home in a variety of contexts, from your bedside table and backyard patio, to restaurants and event spaces.

Colors

Brass
Graphite
White
Black

Dimensions

Wick



Ø 4.7, H 10.2 (in)
Ø 12, H 26 (cm)

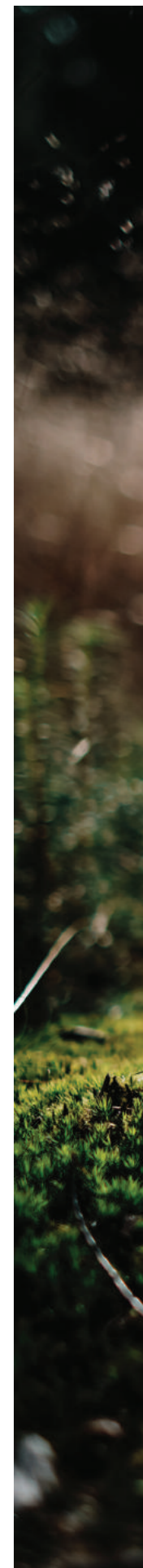



Booi

Through a multifaceted collaboration, Graypants introduces Booi. For Booi, we partnered with Norway-based designer Cathrine Baekken of Studio Heem. And in a manufacturing partnership with Fin design studio, the solid-wood cap is handmade in their Seattle studio—sharing both a parking lot with Graypants, as well as a long-standing friendship. Booi was inspired by glass fishing floats once used by fishermen in many parts of the world, and in which a Norwegian merchant named Christopher Faye is credited with inventing. The design roots are a connection between the rugged maritime landscapes of Bergen, Norway and Seattle, Washington.

Booi was inspired by glass fishing floats once used by fisherman in many parts of the world. These glass floats are no longer used by fishermen, but many of them are still afloat in the world's oceans. They have become a popular collectors' item for beachcombers and decorators alike.





Booi Pendant

A hand finished wooden cap gives a textured, weathered feel, while the linen-covered cord highlights the maritime connection of rope becoming line. Lit through translucent Opal glass, this pendant is a modern reflection of history. Booi comes in two finishes; Ash and Walnut.

Incredibly versatile, the Booi pendant can be hung alone or in groups, or used as an accent light simply resting on a table or the floor.

Colors

Ash

Walnut

Dimensions

Pendant



Ø 60, H 20 (in)
Ø 14, H 18 (cm)



Barro

In an exploration of new materials and mediums, Graypants launches Barro, a pendant lamp designed by Caterina Moretti and made in Oaxaca, Mexico. The partnership between Graypants and Caterina was born of their friendship, kindred design spirit, and a curiosity to explore working with wholly natural materials; Barro is made from clay pulled directly from the earth of Oaxaca, handcrafted and finished with only the power of heat and smoke.



A clay pendant and a hand-blown glass shade are a stunning marriage of natural materials and the result is a handmade piece of art.

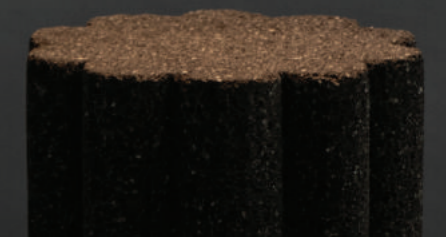

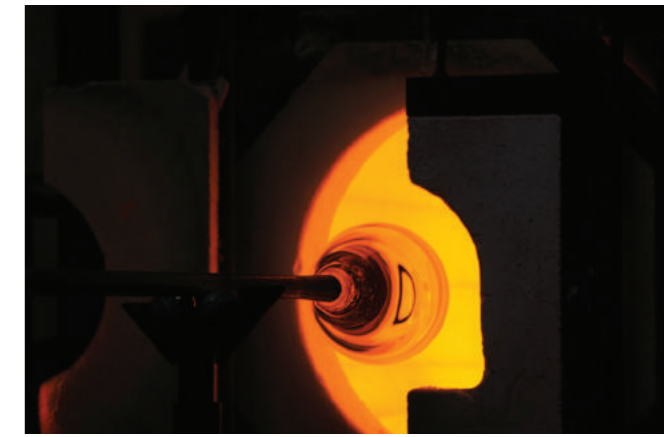

Barro is created using an ancient, region-specific process. It begins with gathering earth from the surrounding areas of Oaxaca to make the clay. Water is added to slake the clay and create slip, which is then poured into handmade plaster molds. The clay pieces are each hand burnished before firing with the help of a river stone, to achieve an iridescent color and smooth feel.

Once the pieces are ready to be fired, they are placed in a special two-vent kiln and stoked continuously for nine hours. The Natural Clay finish is then complete and removed from the kiln. For the Charcoal Clay finish, a process known as reduction of atmosphere takes place: during firing, at a specific moment, the vents are closed to reduce oxygen, generating a chemical reaction that infuses a deep black color in the clay. The clay technique dates back to pre-Hispanic times in Mexico and tells the story of the empirical knowledge of those who came before, and their journey exploring and communicating with nature.

To highlight the ceramic element and the markings made by the fire in it, we added a blown glass dome that envelops and protects it in a symbolic and metaphoric manner, as a display case of sorts, exhibiting the treasures within it.

Barro Pendant

Our pendant lamps are two unique statement pieces. The first is a transparent, hand-blown glass shade embracing the warm, burnished tan clay texture of the handmade hub. The second combines the smoked glass shade with a Oaxacan barro negro finished pendant, subtly bringing to the foreground the traditional burnishing work producing a textured charcoal tone through the additional reduction firing process.

The Barro pendant lamps represent the conjunction of craft and innovation, using traditional techniques to create a modern, unique shape. Incredibly versatile, Barro integrates easily to elevate its surroundings – over a dining table or kitchen island, dotted over a bar in a restaurant or welcoming you in a lobby space.

Colors

- Natural Clay — Clear Glass
- Charcoal Clay — Smoke Glass

Dimensions

Pendant



Ø 6.625, H 13.75 (in)
Ø 17, H 35 (cm)





Scraplights



Scraplights

Scraplights are sustainable fixtures with a versatile aesthetic that elevates both residential and commercial spaces alike. Our series includes table lights, pendants, sconces, and a linear fixture.

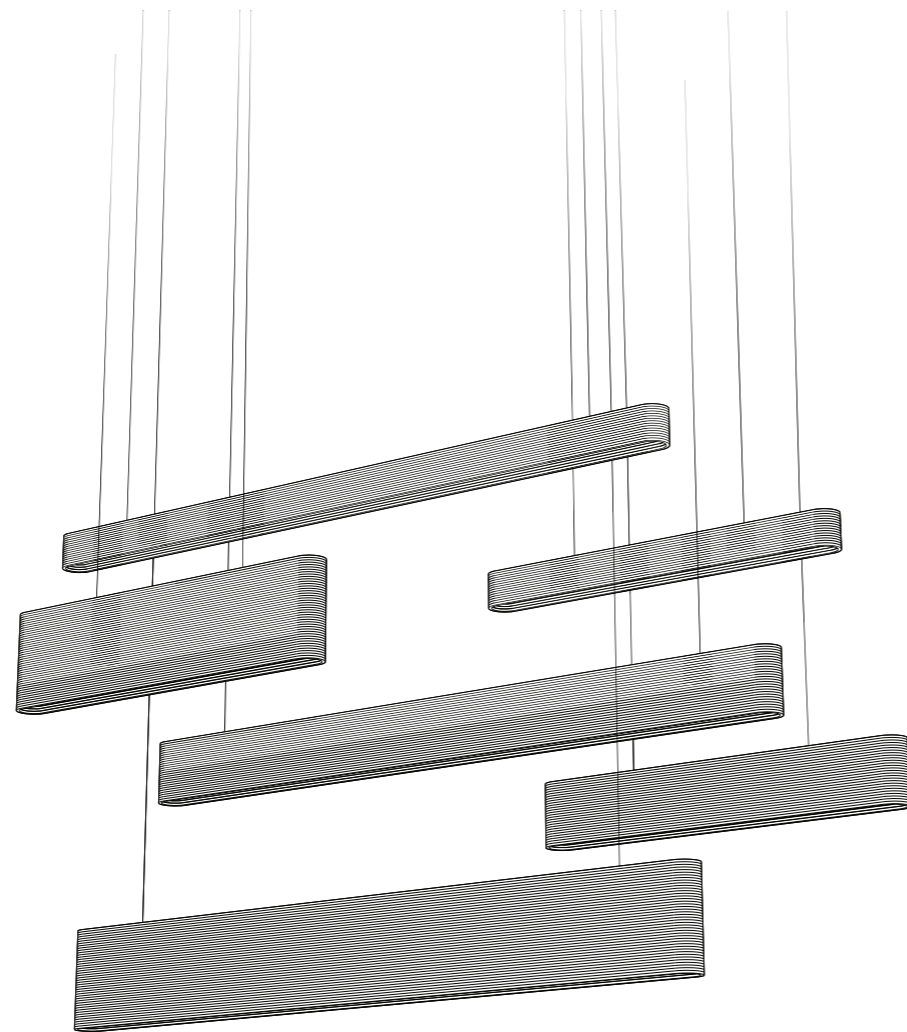

Linear Series



Classic Series



Frame Series

It all started with Scraplights – sourcing post-consumer recycled cardboard and turning it into warm, diffused light. Scraplights have become our signature series, one we continue to love and evolve.

Scraplights



It all started with Scraplights - sourcing post-consumer recycled cardboard and turning it into warm, diffused light. Handmade in our Seattle studio, Scraplights have become our signature series - one we continue to love and evolve. We have since expanded into Europe, with an office in Amsterdam, and a team of makers in partnership with a social works program to provide craft-based work for those who need it most. Using local production gives Graypants the opportunity to provide meaningful work for communities - a great example of the brand's belief in responsible design, responsible materials and responsible production. Design in the end is really about people. Our products are an extension of the people, the faces and the stories behind them.

Depending on the finish, each piece of a Scraplights fixture is precision-cut with a laser or knife - Natural and Blonde welcome the subtle patina of the edge burn from the laser, while the White finish requires the use of a knife to achieve the pristine, white edges. Scraplights are then assembled by hand using non-toxic adhesive and treated with a non-toxic fire retardant. Tough and elegant, Scraplights provide warm, intimate, and functional lighting.

25

Graypants invests in innovative ideas that help create meaningful jobs. We believe our products have stories that transcend their designs. The stories are about the process and the people who take great pride in the quality of their work that goes into crafting and assembling each and every one of our light fixtures.



31

Scraplights

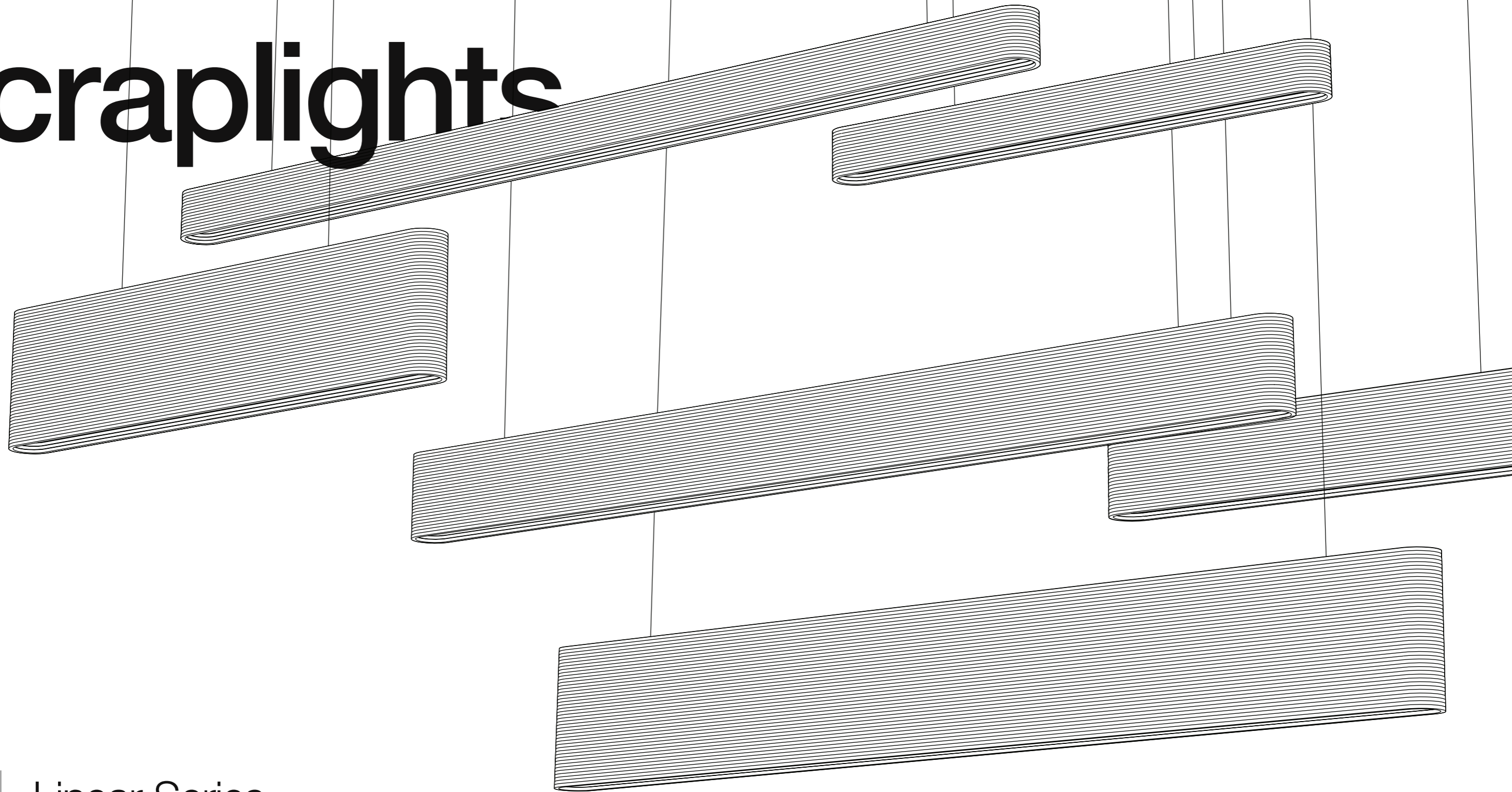

Linear Series

Graypants continues to push and evolve expressions of our iconic Scraplights. Introducing Hewn, a linear shape that is as beautiful as it is hardworking. As a task light, Hewn will deliver more illumination than some of our other Scraplights expressions and the shape is very suitable over a desk, dining table or kitchen island. Hewn is handmade in Graypants' Seattle studio as well as in Amsterdam, and currently available globally.

Scraplights Hewn Linear

With Hewn linear, Graypants adds a tactile and creative addition to a mundane field of task lighting, offering a beautiful light for all kinds of spaces. Hewn reflects a texture created using a new cutting process where layers of the shade are cut parallel to the flutes of the cardboard versus the perpendicular cut lines of our other shapes. This cutting process was intentional allowing us to build something beautiful and textural while also being fully opaque. Serving a wide range of brightness preferences, Hewn is dimmable and performs very well in both a home environment or commercial space. Hewn is available in three finishes—Natural, White and Blonde—and several lengths and heights

Colors

- Natural
- Blonde
- White

Dimensions

Hewn48		L 47.5, W 4, H 4.25 (in) L 121, W 10, H 11 (cm)
Hewn48		L 47.5, W 4, H 7.75 (in) L 121, W 10, H 20 (cm)
Hewn48		L 47.5, W 4, H 11.75 (in) L 121, W 10, H 30 (cm)





Scraplights



Classic Series

Graypants continues to play and explore ways to apply cardboard in new and unique expressions. The classic series includes many of the best-selling silhouettes such as the Moon and Disc, along with newer designs like our most recent launch of the Madison within our Pebbles collection.



Scraplights Skew

Skew is the first Scraplights sconce and the perfect compliment to any Scraplights silhouette. Offered in three sizes, each is ADA compliant at 4 inches (10.2cm) in depth and uses a LED lamp. Slim yet substantial, Skew gives a radiant glow that is perfect for illuminating a hallway in an office or hotel, or could just as easily rest above bedside tables.

Colors

Natural
Blonde
White

Dimensions

Skew13



W 13, D 4, H 16.75 (in)
W 33, D 10, H 43 (cm)

Skew15



W 15, D 4, H 9.75 (in)
W 40, D 10, H 25 (cm)

Skew22



W 22, D 4, H 14.25 (in)
W 56, D 10, H 36 (cm)



Scraplights Moon

Colors

- Natural
- Blonde
- White

Dimensions

Moon10

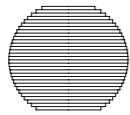

Ø 10, H 9 (in)
Ø 26, H 22 (cm)

Moon14

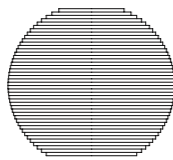

Ø 14, H 12 (in)
Ø 36, H 31 (cm)

Moon18

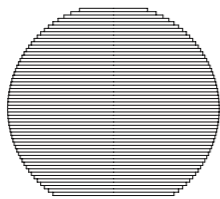

Ø 18, H 16 (in)
Ø 45, H 40 (cm)

Moon24

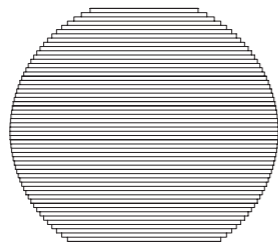

Ø 24, H 21 (in)
Ø 61, H 53 (cm)

Moon10
Table Lamp

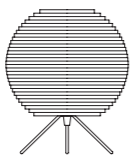

Ø 10, H 12 (in)
Ø 25.5, H 30 (cm)



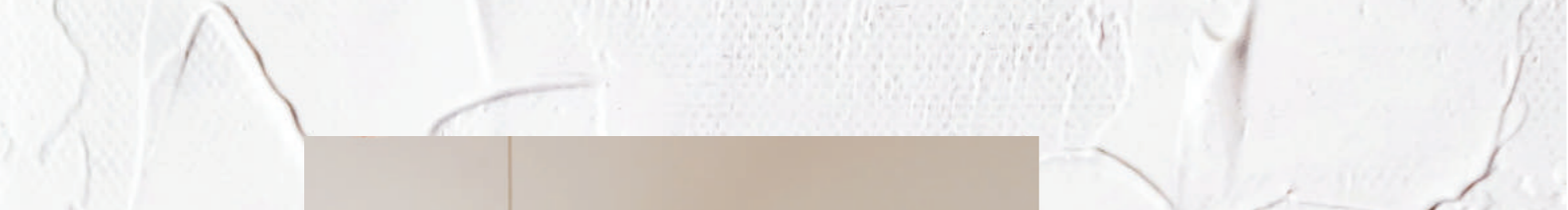



Scraplights Disc

Colors

- Natural
- Blonde
- White

Dimensions

Disc16

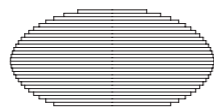

Ø 17, H 7 (in)
Ø 43, H 19 (cm)

Disc20



Ø 20, H 9 (in)
Ø 50, H 23 (cm)

Disc24



Ø 24, H 10 (in)
Ø 61, H 26 (cm)





Scraplights Drop

Colors
Natural
Blonde
White

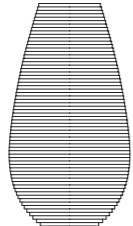
Dimensions
Drop18

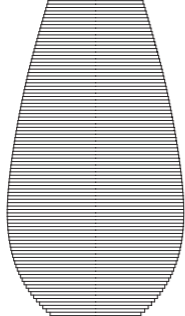
Ø 10, H 18 (in)
Ø 25, H 45 (cm)

Drop26

Ø 14, H 26 (in)
Ø 36, H 65 (cm)







Scraplights Bell

Colors

Natural
Blonde
White

Dimensions

Bell10

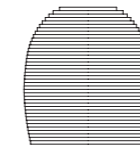

Ø 11, H 11 (in)
Ø 27, H 28 (cm)

Bell16

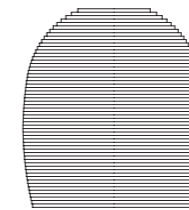





Ø 15, H 16 (in)
Ø 38, H 40 (cm)

Scraplights Ausi

Colors

- Natural
- Blonde
- White

Dimensions

Ausi8		Ø 7.75, H 9.5 (in) Ø 20, H 24 (cm)
Ausi12		Ø 11, H 8.5 (in) Ø 28, H 21 (cm)
Ausi14		Ø 14.75, H 14 (in) Ø 38, H 36 (cm)
Ausi8 Table Lamp		Ø 7.75, H 12.25 (in) Ø 20, H 31 (cm)





Scraplights Pebbles

The latest addition to the Scraplights collection takes forms from pebbles gathered from various beaches near Graypants' Seattle studio. Each pebble shade is inscribed with the beach name and coordinates of the original stone that inspired it.

Colors

- Natural
- Blonde
- White

Dimensions

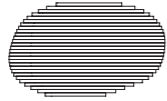
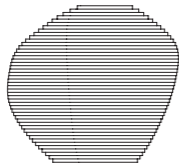
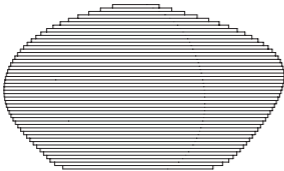
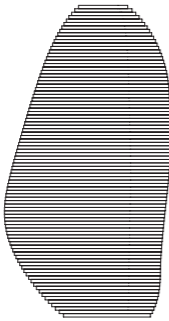
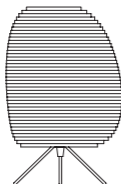
Alki		Ø 12.5, H 7.5 (in) Ø 32, H 19 (cm)
Allyn		Ø 14, H 13.25 (in) Ø 36, H 33 (cm)
Madison		Ø 23.5, H 13 (in) Ø 60, H 33 (cm)
Denny		Ø 13.5, H 25.5 (in) Ø 34, H 65 (cm)
Ebey		Ø 10, H 16 (in) Ø 25, H 40 (cm)

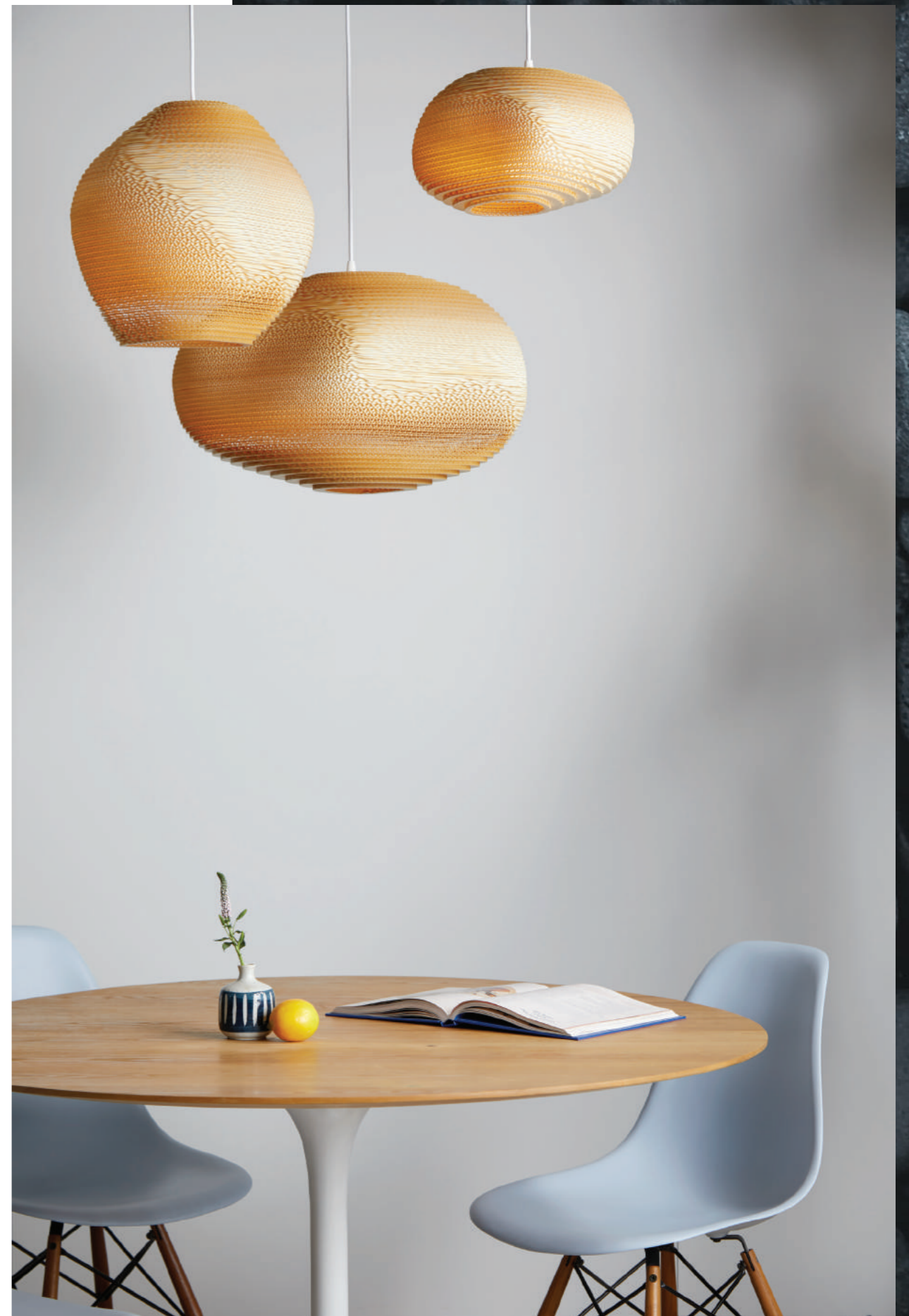

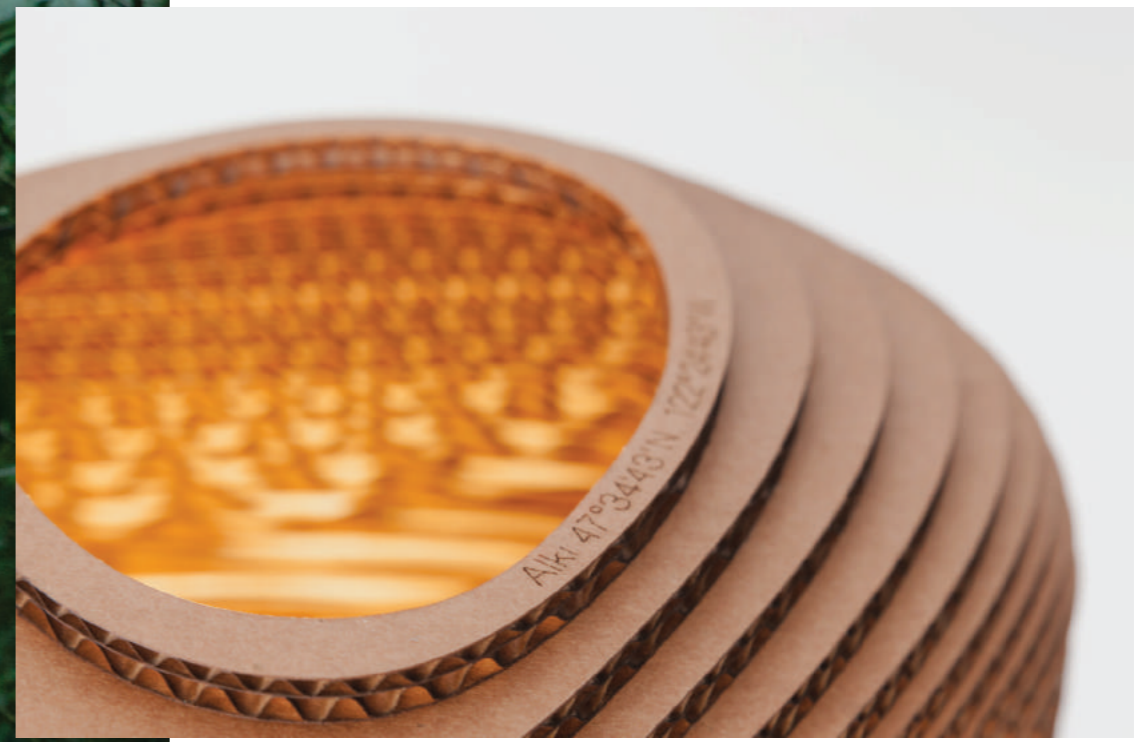





Scraplights Hive

Colors

- Natural
- Blonde
- White

Dimensions

Hive9

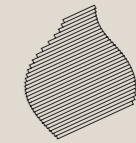

Ø 9, H 11 (in)
Ø 23, H 28 (cm)

Hive12

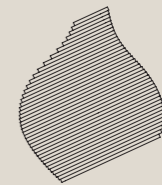

Ø 12, H 14.25 (in)
Ø 30, H 36 (cm)

Hive15

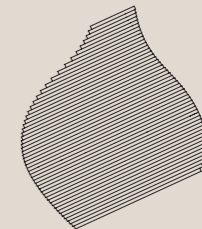

Ø 15, H 18.25 (in)
Ø 38, H 46 (cm)

Scraplights Nest

Colors

- Natural
- Blonde
- White

Dimensions

Nest24

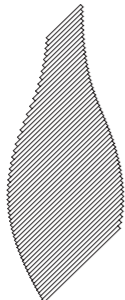

Ø 9.25, H 24.25 (in)
Ø 24, H 62 (cm)

Nest32

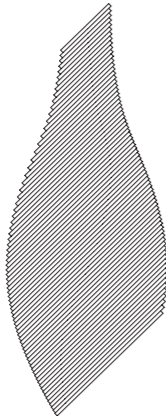

Ø 13.25, H 33.5 (in)
Ø 34, H 85 (cm)







Scraplights Oliv

Colors

- Natural
- Blonde
- White

Dimensions

Oliv

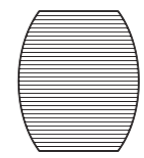

Ø 7, H 9 (in)
Ø 19, H 22 (cm)

Scraplights

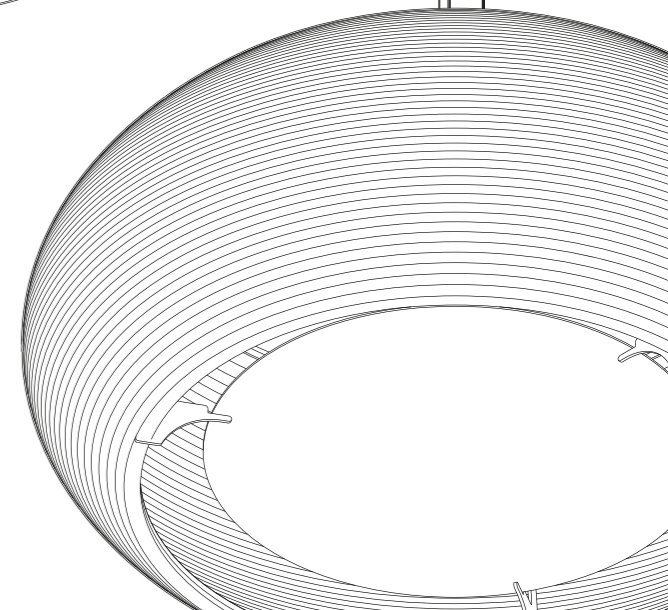
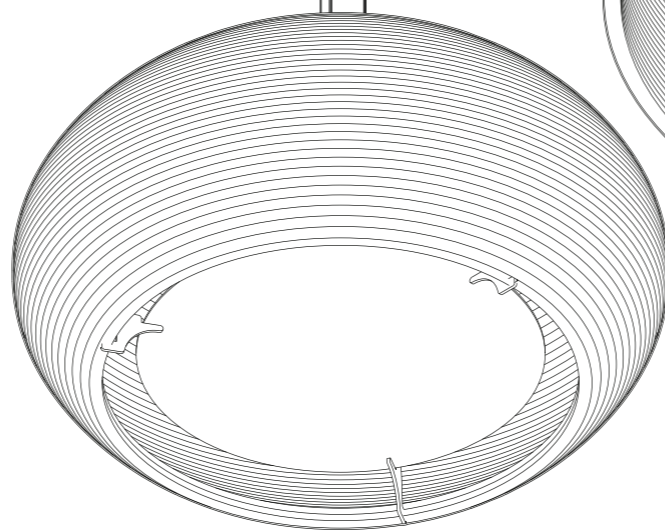
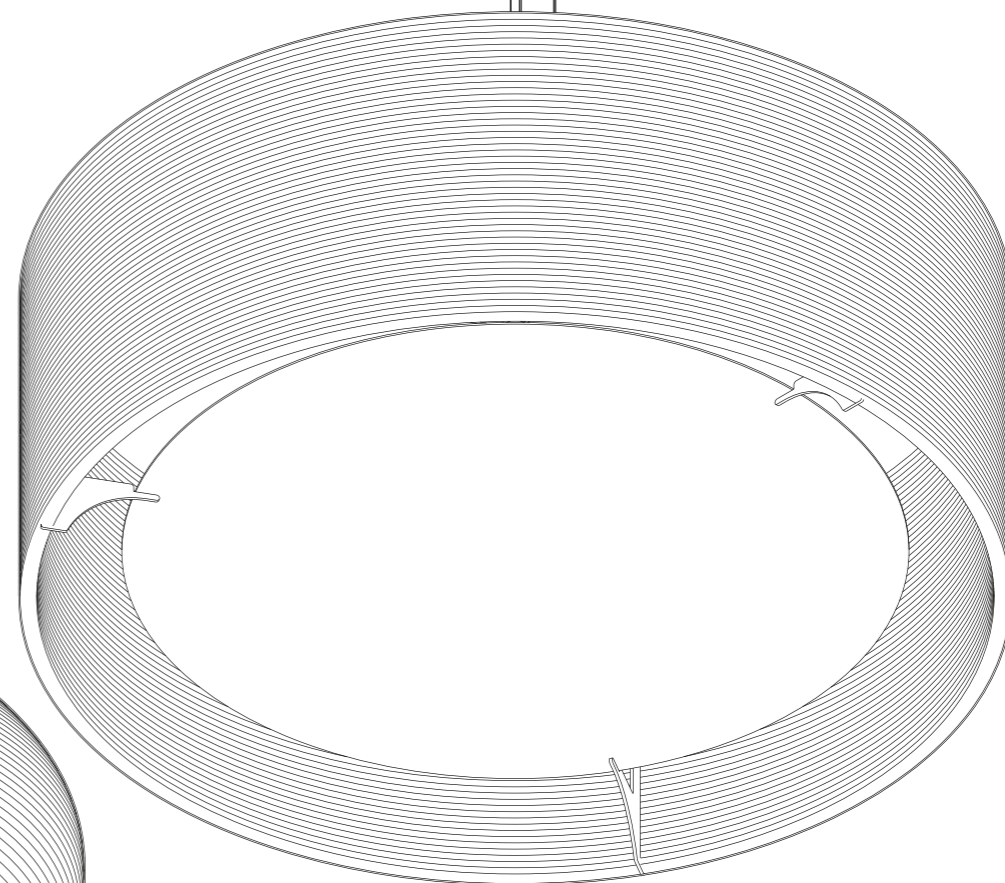
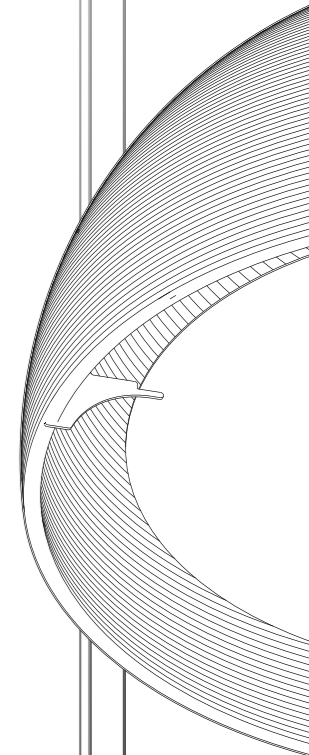
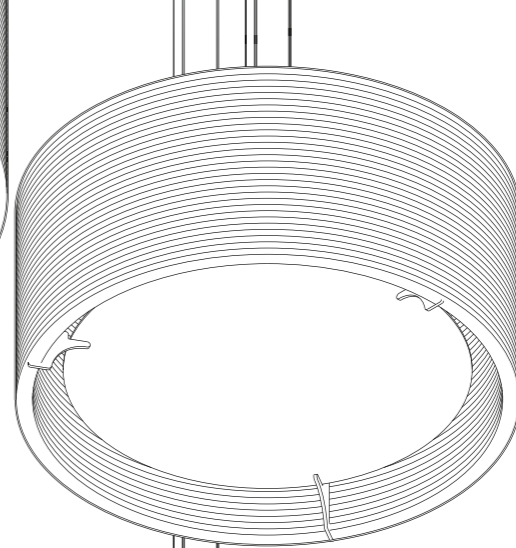
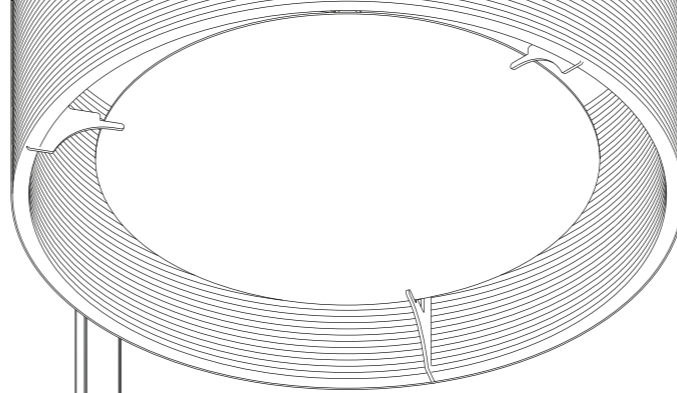
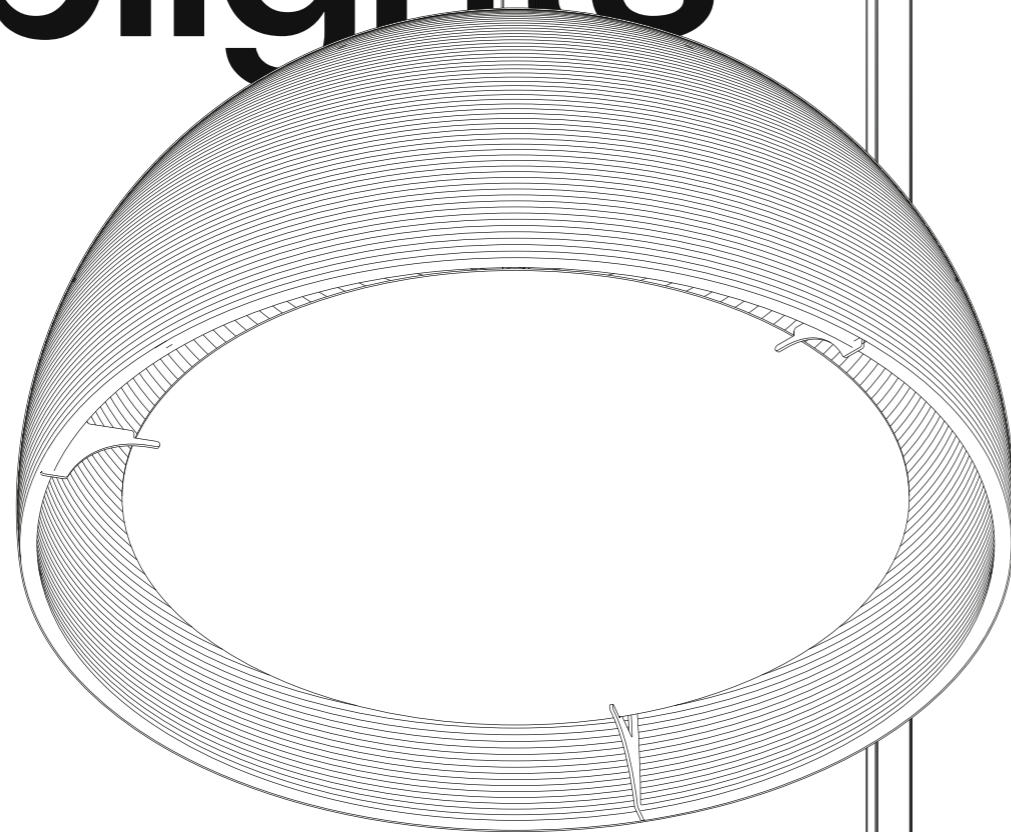

Frame Series

The Frame Series represents our largest manifestations of Scraplights. Frame pendants combine the classic layered cardboard expression with a steel frame and a frosted glass diffuser. This creates a visually arresting decorative piece with excellent top and bottom lighting for large spaces such as lobbies and conference rooms.



Scraplights Drum

Colors

- Natural
- Blonde
- White

Dimensions

Drum18

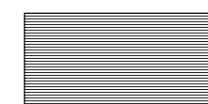

Ø 18, H 8.5 (in)
Ø 46, H 22 (cm)

Drum24

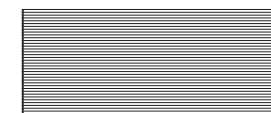

Ø 24, H 9.5 (in)
Ø 61, H 24 (cm)

Drum36

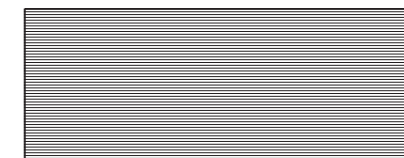

Ø 36, H 13.5 (in)
Ø 92, H 34 (cm)



Scraplights Ohio

Colors

- Natural
- Blonde
- White

Dimensions

Ohio24



Ø 24, H 10.25 (in)
Ø 61, H 26 (cm)

Ohio32

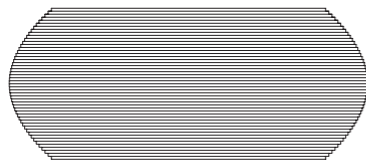

Ø 31.75, H 13.25 (in)
Ø 81, H 35 (cm)





Scraplights Dome

The Dome pendant combines half of the well-known Sun32 design with an even larger diffuser, making it ideal for spaces needing more functional lighting, such as an open office or event space.

Colors

- Natural
- Blonde
- White

Dimensions

Dome36

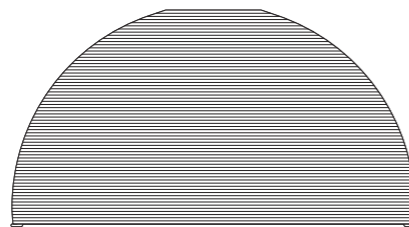

Ø 36.5, H 19.75 (in)
Ø 93, H 50 (cm)







Scraplights Sun

Colors

- Natural
- Blonde
- White

Dimensions

Sun32

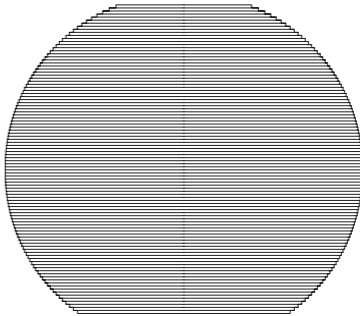

Ø 32, H 29.25 (in)
Ø 81, H 74 (cm)

Sun48

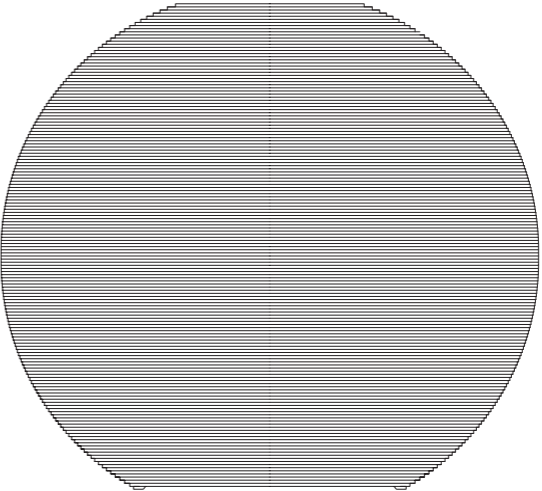

Ø 47, H 43 (in)
Ø 128, H 108 (cm)

Scraplights Arcturus

Colors

- Natural
- Blonde
- White

Dimensions

Arcturus

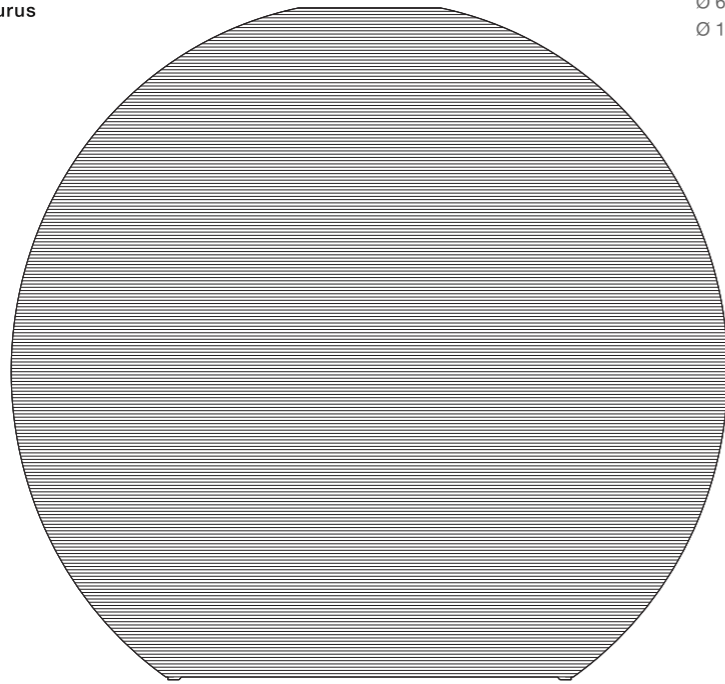

Ø 64, H 58 (in)
Ø 163, H 147 (cm)





Chrona

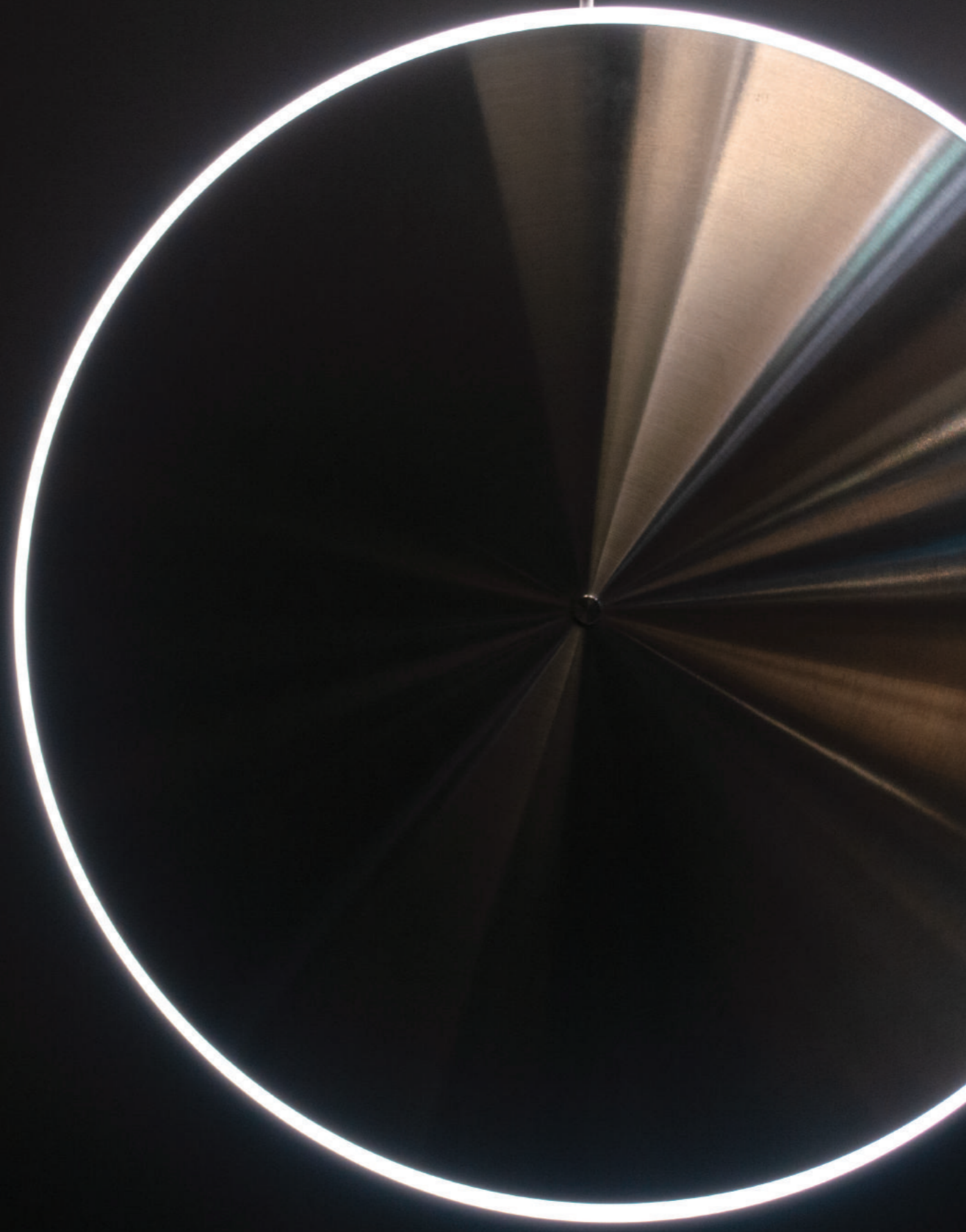

Chrona

Chrona fixtures are warm, modern expressions, harnessing a charm that is both timeless and futuristic. Spun brass comes together sandwiching an acrylic diffuser that traces the silhouette of each fixture, providing even diffusion of the integrated LED light source. Chrona is available in both horizontally or vertically oriented pendants, and also as a sconce or table lamp. With a variety of sizes and configurations, Chrona can be clustered together to make constellations or stand out alone.

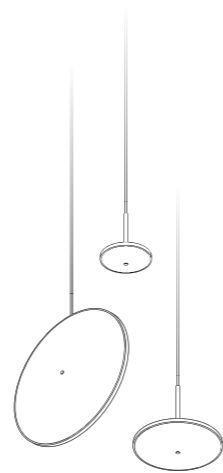

Dish Pendant

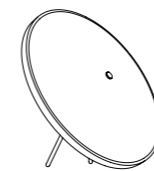
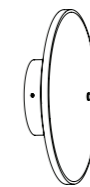

Table lamp



Sconce

Mimicking the phosphorescent envelope found around stars, Chrona creates a warm, atmospheric glow.

Chrona Pendant

Much like staring into the night sky, Chrona dish pendants hang freely, allowing the user to experience the natural refraction and twinkling of light coming from subtle movement and playing off the beautifully finished brass.

Slim and robust, the pendants are available in diameters ranging from 6 to 17 inches. Offered in both horizontal and vertical orientations, Chrona dish pendants can combine to create stunning constellation-inspired clusters, or can be individually hung to accentuate an area.

Colors

- Brass
- Stainless Steel

Dimensions

Dish6h



Ø 5.5, H 7 (in)
Ø 14, H 18 (cm)



Ø 5.5, D 2 (in)
Ø 14, D 5 (cm)

Dish10h



Ø 9.5, H 9.25 (in)
Ø 24, H 23 (cm)



Ø 9.5, D 2.25 (in)
Ø 24, D 6 (cm)

Dish17h



Ø 16.75, H 11.5 (in)
Ø 43, H 29 (cm)

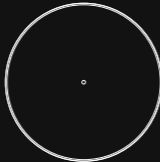

Ø 16.75, D 3" (in)
Ø 43, D 7 (cm)





Chrona Table Lamp

Colors

Brass

Dimensions

Table10

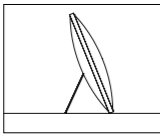

W 9.5, D 5.25, H 8.5 (in)
W 24, D 13, H 22 (cm)

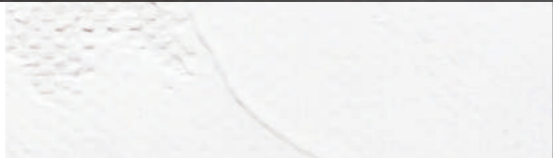



Chrona Sconce

Taking direct inspiration from a solar eclipse, the Chrona wall sconce is a powerful expression giving off a subtle, warm glow.

The Chrona wall sconce can be affixed to the wall in mixed clusters, or used alone as a singular, modern element.

Colors

Brass

Dimensions

Sconce10

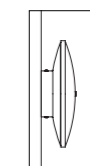

Ø 9.5, D 3 (in)
Ø 24, D 8 (cm)

Roest

/roōst/



Roest

/roōst/

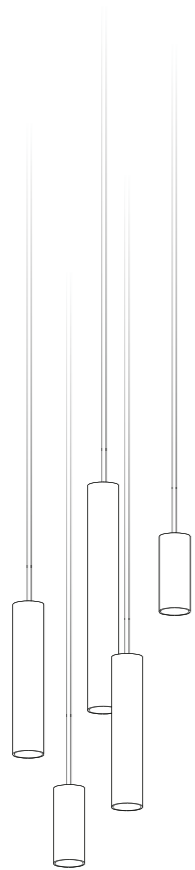

Pendant

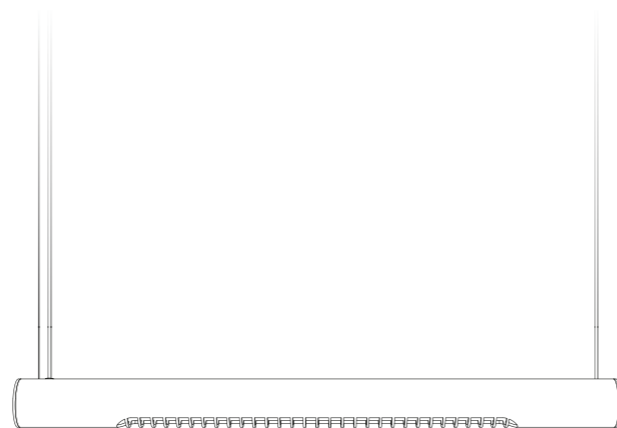

Linear

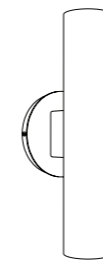

Sconce

For Roest, we partnered with Netherlands-based designer VanJoost. In his native language, roest means rust, and this highly textured series shows the natural relationship between the elements, time, oxygen, and iron. Roest highlights Graypants unique fascination with nature and material research. Roest is made from naturally rusted and zinc-coated steel, and powered by a LED bulb. A minimal black cord connects to a black powder coated canopy. Bringing textures we usually experience in nature to the interior environment. Roest makes the industrial delicate, and lends warmth to a sleek modern form.

Roest is available as a pendant, sconce, and linear fixture, and adds focused light to office, home, and hospitality settings.

Bringing textures we usually experience in nature to the interior environment. Roest makes the industrial delicate, and lends warmth to a sleek modern form.

Roest

/roōst/

In their first outside collaboration, Graypants teamed up with Dutch designer VanJoost to expand on their curiosities and learn the craft of another designer. The collaboration with VanJoost highlights Graypants unique fascination with nature and material research.

Roest reflects unpretentious simplicity, and the unique finish on every single piece is what makes this collection truly special. To achieve the desired patina, each piece is finished by hand, and no two are alike. VanJoost starts with raw, steel pipes and rinses them in a vinegar bath which seeps into the pores of the metal creating a hardy and pitted surface - this helps the subsequent rusting process set in, in a deeper way. Each piece is then treated with a solution that starts a chemical reaction accelerating the effects of how elements would impact steel over time - a process that would otherwise take more than six months. Designed by VanJoost and hand-made in Holland, Roest presents natural colors that elevate any setting.





Roest Pendant

Colors

- Rust
- Rust + Zinc
- Zinc
- Carbon

Dimensions

15v Pendant



Ø 2.375, H 6 (in)
Ø 6, H 15 (cm)

30v Pendant



Ø 2.375, H 11.75 (in)
Ø 6, H 30 (cm)

45v Pendant



Ø 2.375, H 17.75 (in)
Ø 6, H 45 (cm)



Roest Linear

Colors

- Rust
- Zinc
- Carbon

Dimensions

75h Pendant

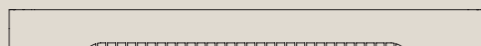

Ø 2.375, L 29.5 (in)
Ø 6, W 75 (cm)

150h Pendant

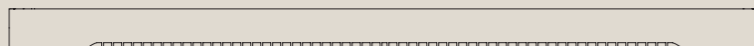

Ø 2.375, L 59 (in)
Ø 6, W 150 (cm)





Roest Sconce

Colors

- Rust
- Zinc
- Carbon

Dimensions

Sconce30

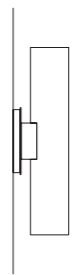

Ø 2.375, H 11.75 (in)
Ø 6, H 30 (cm)





Roest Ceiling

Colors

Rust

Dimensions

Ceiling10

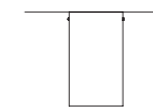

Ø 4.5, H 8 (in)
Ø 11.4, H 20 (cm)



Kerflights



Kerflights

Finding the line between the strength and flexibility of wood, Kerf harnesses a texture that feels natural, but was created with technological precision. Handmade in our Seattle studio, the shade panels are swappable and reversible, allowing for change over their long lives.

Kerf is made with FSC-certified, high-quality plywood, wrapped around durable powder-coated steel wire frames, providing a distinct shape.

Kerf is available as a pendant and sconce, and performs well in commercial spaces, offices, and homes.

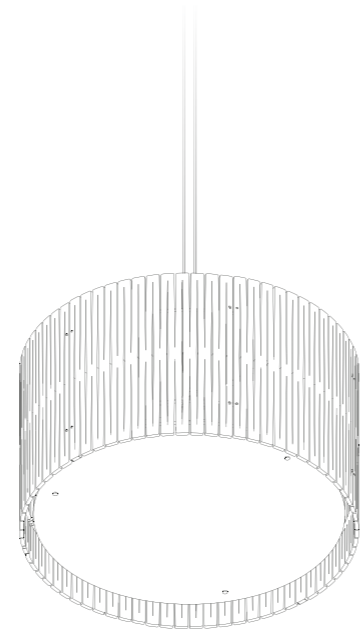

Drum

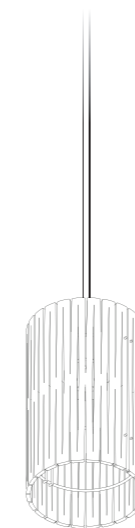

Pendant

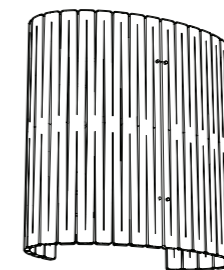

Sconce

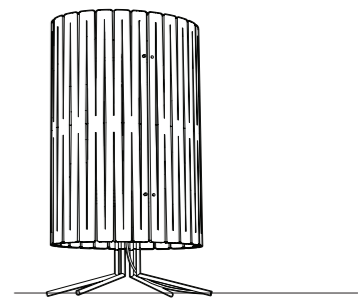

Table Lamp

Finding the line between the strength and flexibility of wood, Kerf harnesses a texture that feels natural, but was created with technological precision.



Kerflight Drum

Colors

- Blackened Ash
- Light Ash
- Black Walnut
- White Oak

Dimensions

D6 Drum

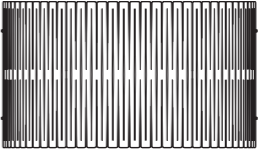

Ø 22, H 13 (in)
Ø 55, H 32 (cm)

D9 Drum

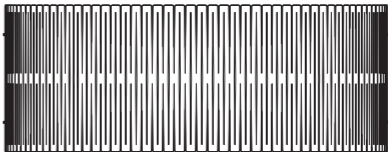

Ø 33, H 13 (in)
Ø 83, H 32 (cm)



Kerflight Pendant

Colors

Blackened Ash

Light Ash

Black Walnut

White Oak

Dimensions

P2 Pendant



Ø 7, H 13 (in)
Ø 18, H 32 (cm)





Kerflight Sconce

Colors

- Blackened Ash
- Light Ash
- Black Walnut
- White Oak

Dimensions

S2 Sconce

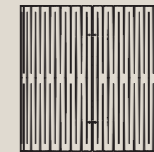

Ø 12, H 13, D 6 (in)
Ø 30, H 32, D 14 (cm)



Kerflight Table Lamp

Colors

- Blackened Ash
- Light Ash
- Black Walnut
- White Oak

Dimensions

T2 Table Lamp



Ø 8, H 15 (in)
Ø 21, H 39 (cm)

Murmurations



Murmurations

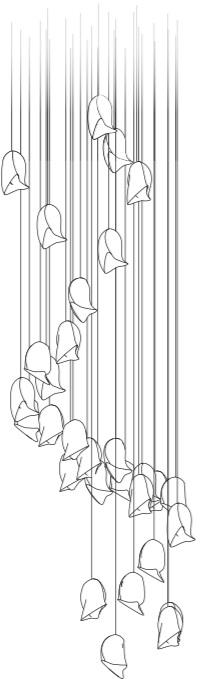

Tornado

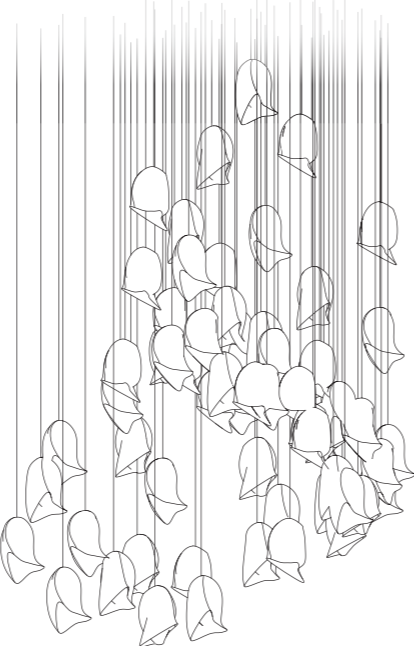

Flock Small

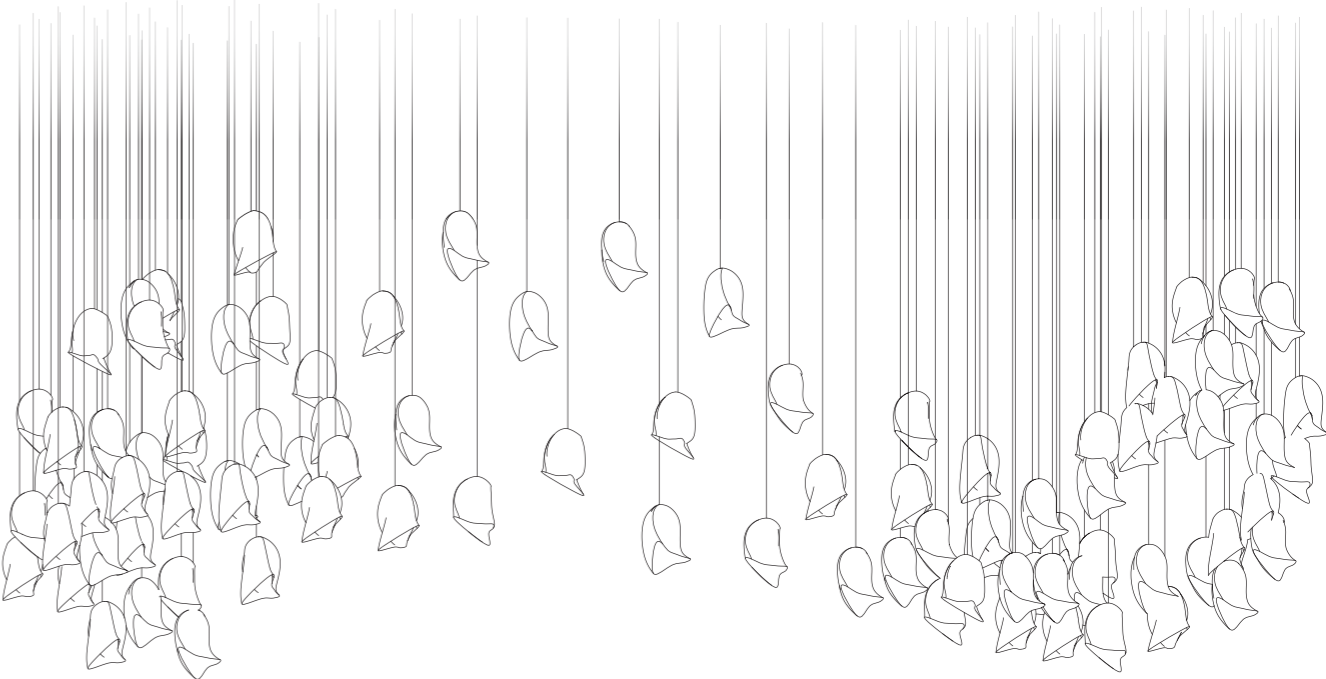

Flock Large

Murmurations are custom installations inspired by the breathtaking natural phenomenon of Flocking and the incredible sight of thousands of starlings flying together in unison. Flocking is considered an emergent behavior arising from simple rules that are followed by individuals without any central coordination. By creating our own simple design rules, we are able to create dynamic light installations comprising of a single layered cardboard pendant. A Murmurations fixture is a versatile and spectacular LED chandelier with endless customization possibilities, from just a few to hundreds of pendants, installations can be customized to fit your specifications and make a grand impression in any space.

Murmurations are fixed shapes, but the relationship of each individual pendant within the group creates an experience of complex motion.





Loci



Loci

The Loci suspension light works especially well in large open spaces such as building lobbies and tall spaces such as stairwells, where the light can be customized to create spectacular installations.

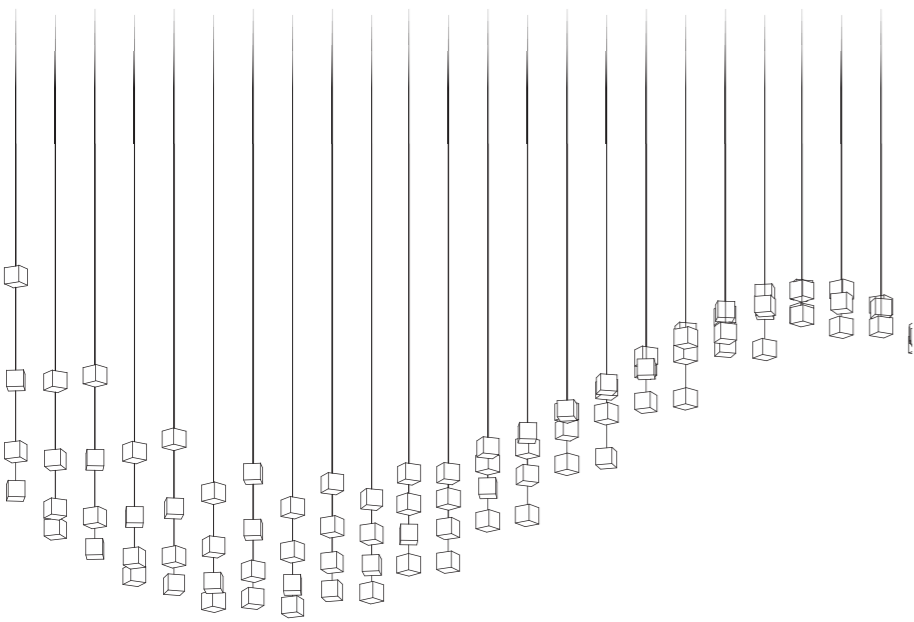

Wave

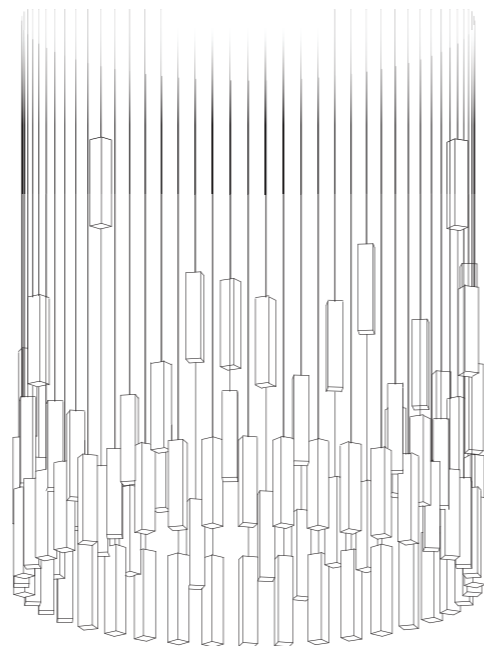

Ring

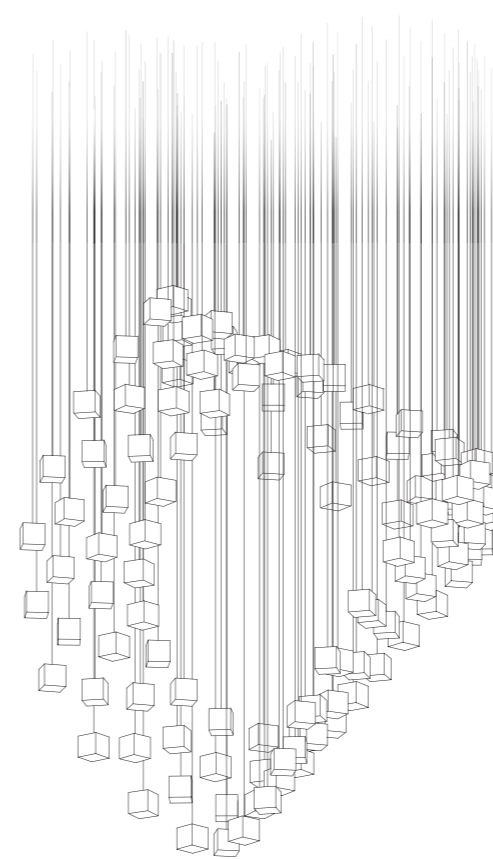

Mobius

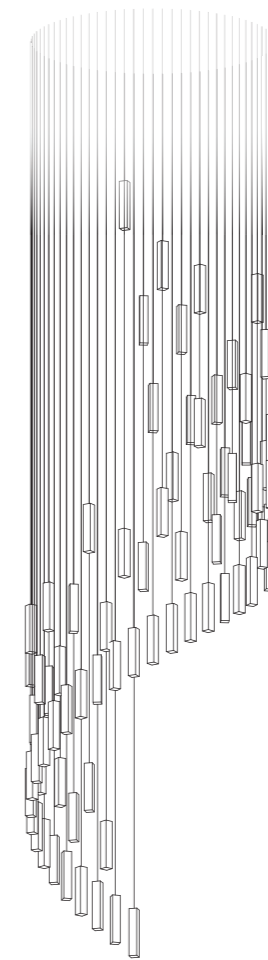

Spiral Ring

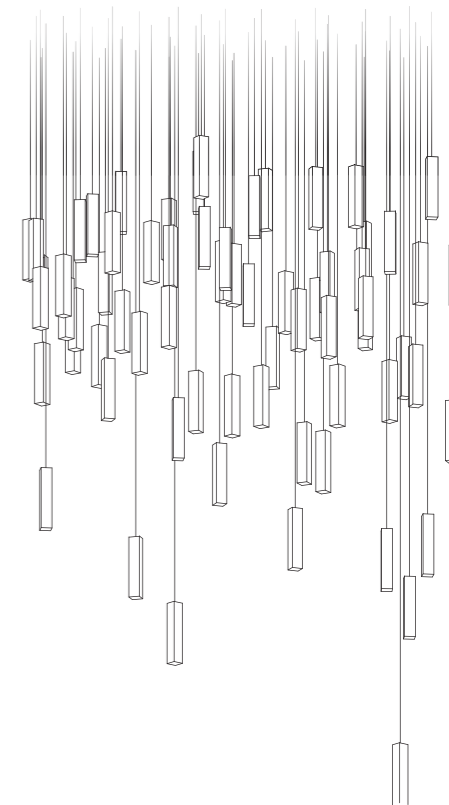

Rain

Loci is an innovative and highly customizable suspension light. The name, Latin in origin, translates to a particular position, point, or place, and refers to the series' innovative method of achieving hundreds or thousands of singular points of light in an installation.

Loci comes in five standard designs: Wave, Ring, Mobius, Spiral Ring and Rain, but any number of pendants can be used to create unique designs customized to fit your specifications. The individual pendants within each design are made of solid frosted diffusers and can also be specified in various shapes. When lit, the pendants emit a soft glow highlighting their respective designs in tandem with a powerful expression of the overall design of the installation.





Custom Projects

Custom installations represent the intersection of imagination and specificity, allowing for something truly unique and awe-inspiring, that is also created with intention for the surrounding space and the users who will share the experience.

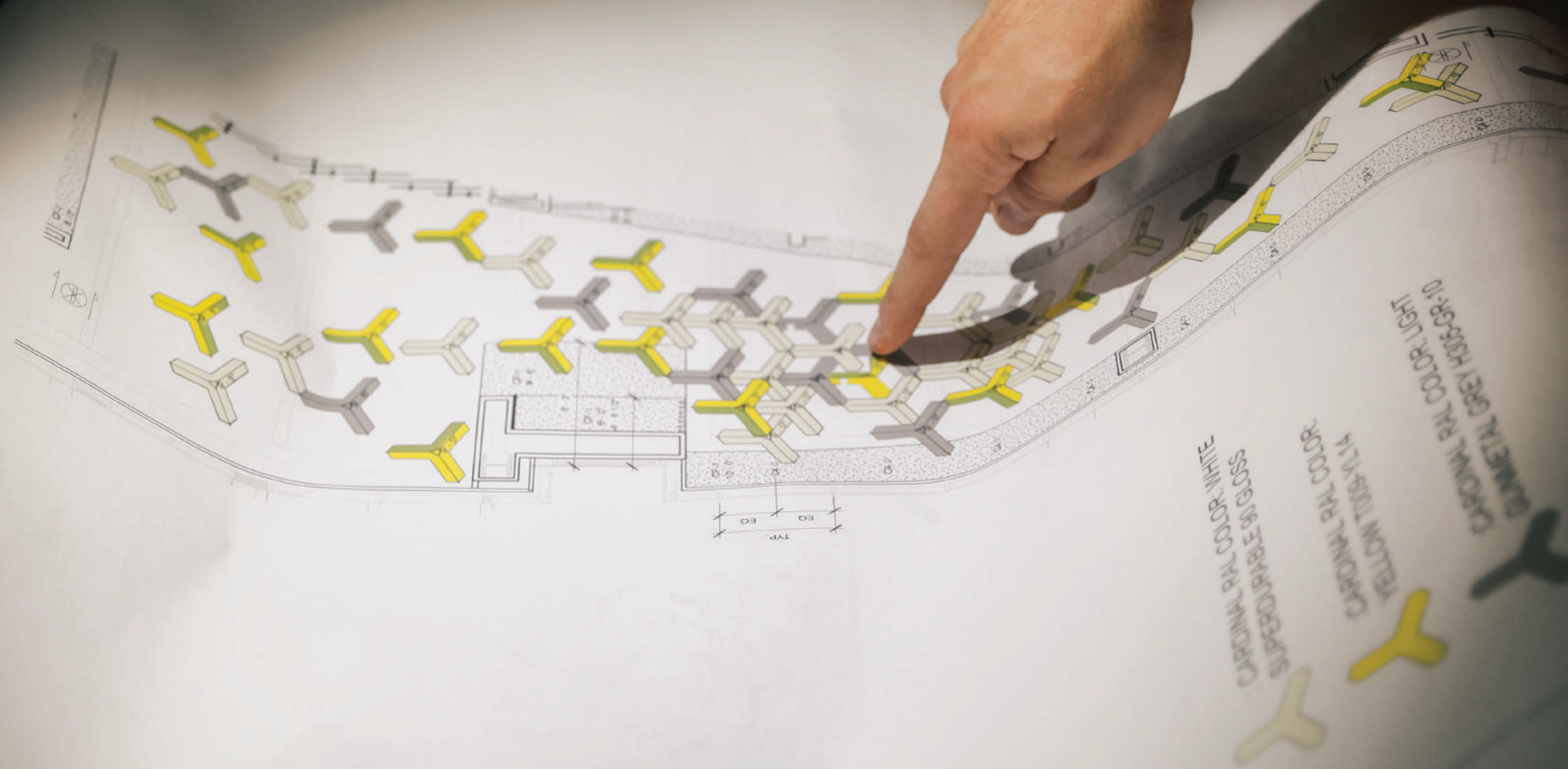

Design Collaboration



Custom metal work, signage and lighting for Mbar, Seattle



Cloud Installation

with programmable lighting



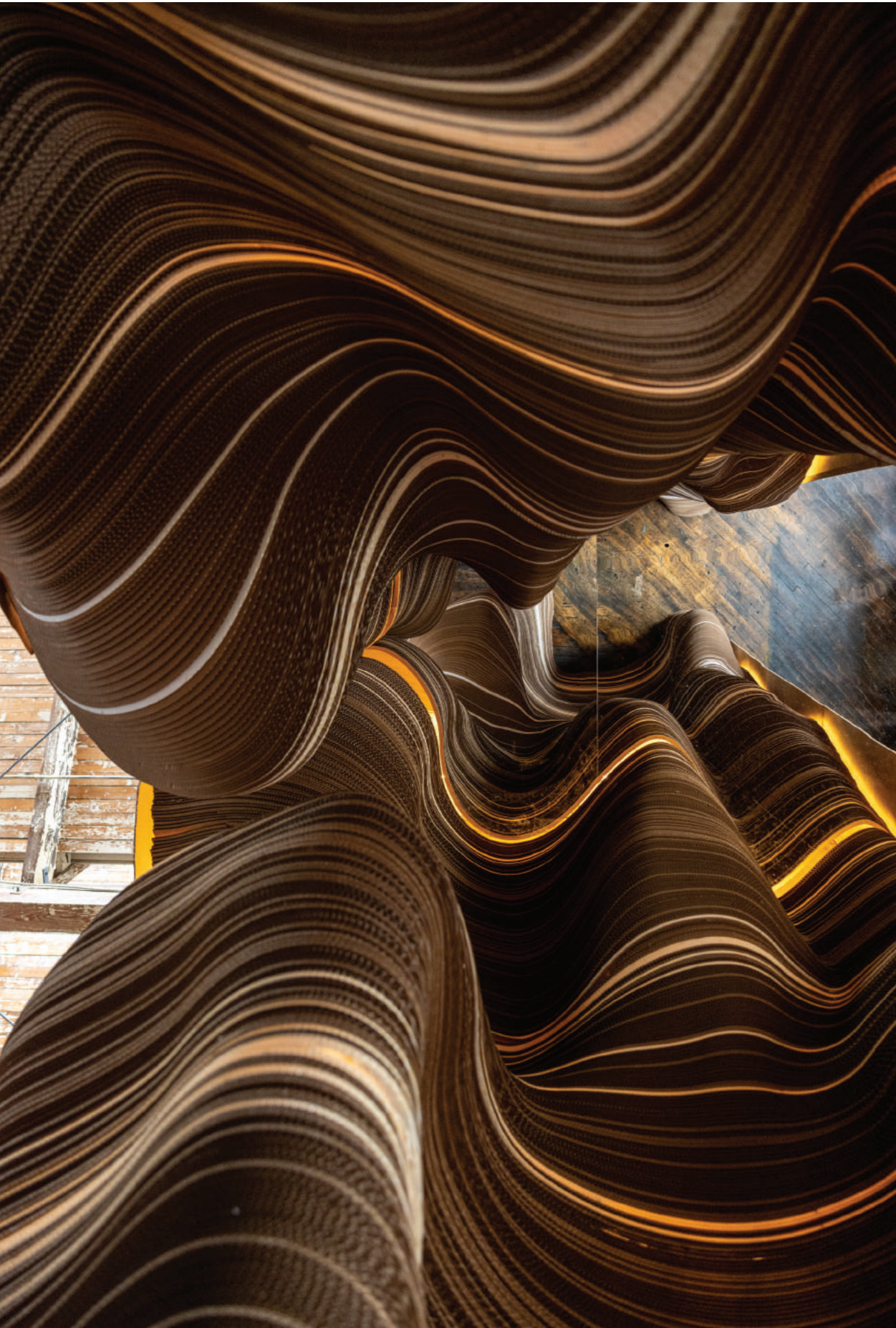

Custom Canyon Walls



Alaska Airlines Lounge

Custom Panels



Prop Ceiling System

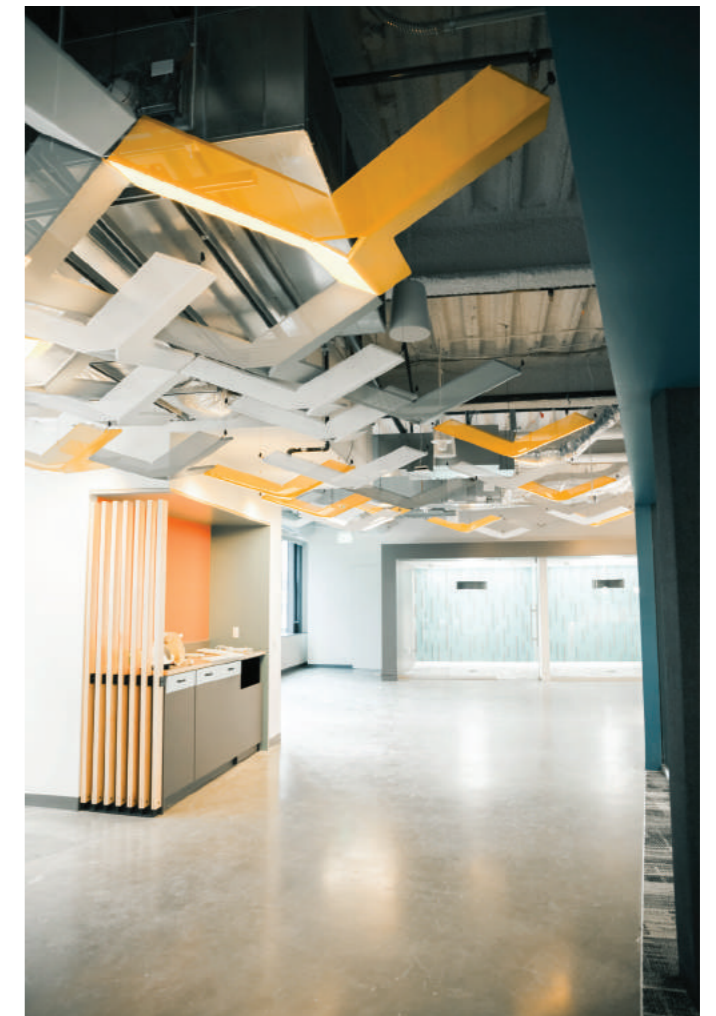



Canopy

Using a canopy is the greatest way to showcase Graypants lighting products. The canopy refers to a powder coated, metal plate that allows us to group multiple pendant lights into endless clustered configurations. Whether it is a cascading array of Roest pendants, or a large grouping of Scraplight Moons in various dimensions, canopy clusters have a dramatic visual impact. Akin to sculpture, using a canopy allows us to create compositions where the lights work together to create an artistic element in a space versus using singular lit elements.

We offer canopies in either circular or rectangular configurations, and in various sizes therein. Incredibly versatile, the canopy can be mounted flush or suspended, and hung together in multiples to cover large areas.

We have numerous standard configurations, and can also create something totally custom to fit any space. Using a canopy can truly showcase the strength of the artistic capabilities of Graypants. We enjoy working closely with our designers and customers to create something meaningful that will be appreciated for a lifetime. Whether creating an exceptionally beautiful moment in your dining room, or over a staircase in a commercial space, the uses and expressions are endless.



Circular Canopy

Colors

Black

Custom colors available

Dimensions

Side

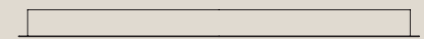

36 x 36 x 2.6 (in)
91 x 91 x 6.6 (cm)

Top

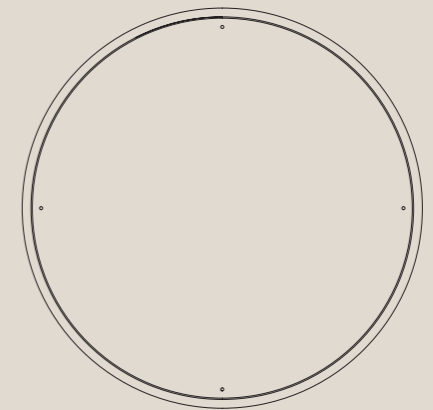

Circular Canopy Configurations

Moon 5
Single circular canopy
5 pendants
1.5m drop

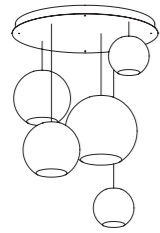

Drop 5
Single circular canopy
5 pendants
1.5m drop

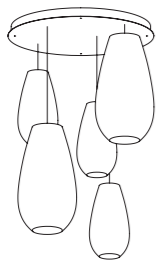

Pebble 5
Single circular canopy
5 pendants
1.5m drop

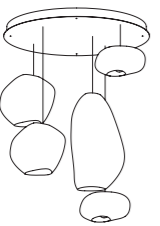

Ausi 5
Single circular canopy
5 pendants
1.5m drop

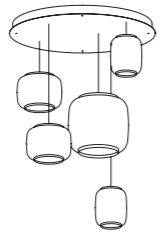

Disc 5
Single circular canopy
5 pendants
1.5m drop

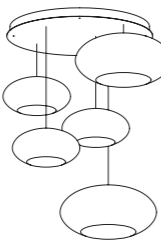

Chrona 5
Single circular canopy
5 pendants
1.5m drop

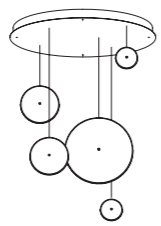

Hive/Nest 5
Single circular canopy
5 pendants
1.5m drop



Bell 5
Single circular canopy
5 pendants
1.5m drop

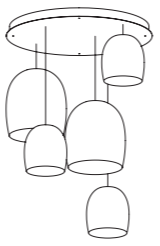

Roest 5
Single circular canopy
5 pendants
1.5m drop

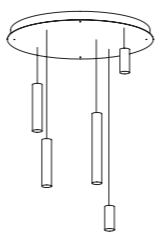

Moon 11
Single circular canopy
11 pendants
3m drop

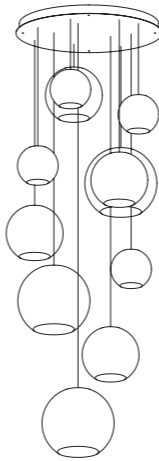

Bell 11
Single circular canopy
11 pendants
3m drop

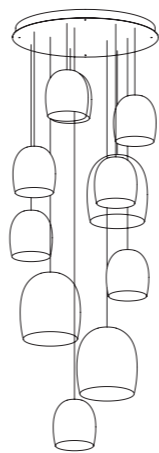

Ausi 11
Single circular canopy
11 pendants
3m drop

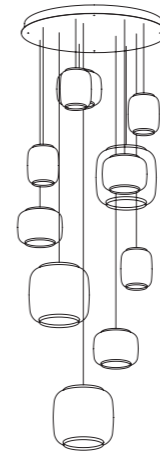

Pebble 11
Single circular canopy
11 pendants
3m drop

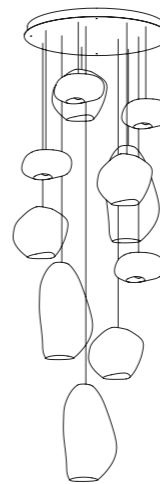

Hive/Nest 11
Single circular canopy
11 pendants
3m drop

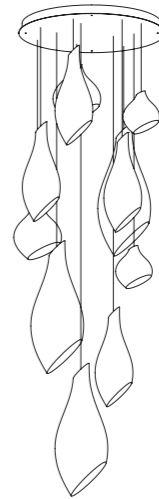

Chrona 11
Single circular canopy
11 pendants
3m drop

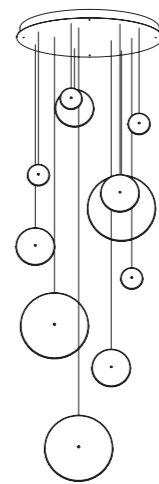

Drop 11
Single circular canopy
11 pendants
3m drop

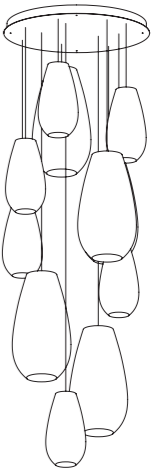

Roest 11
Single circular canopy
11 pendants
3m drop



Rectangular Canopy

Colors

Black
Custom colors available

Dimensions

Rectangle
Side

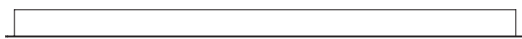

23.2 x 46.5 x 2.6 (in)
59 x 118 x 6.6 (cm)

Rectangle
Top

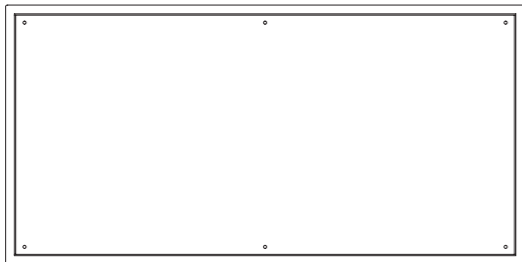

Linear
Top

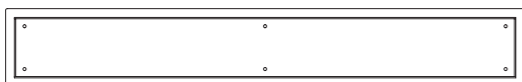

7 x 46.5 x 2.6 (in)
18 x 118 x 6.6 (cm)



Rectangular Canopy Configurations

Scraplights Mix 14

Single rectangular canopy
14 pendants
2.5m drop

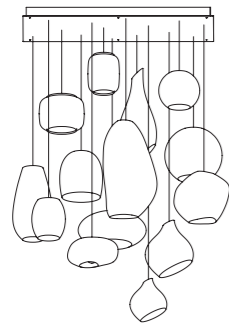

Moon 7

Single rectangular canopy
7 pendants
2.5m drop

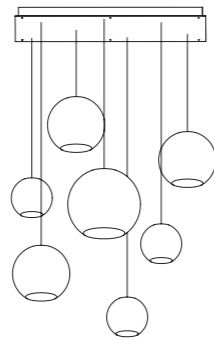

Ausi 7

Single rectangular canopy
7 pendants
2.5m drop

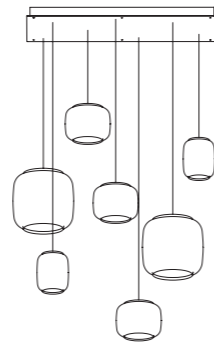

Hive/Nest 7

Single rectangular canopy
7 pendants
2.5m drop



Chrona 7

Single rectangular canopy
7 pendants
2.5m drop

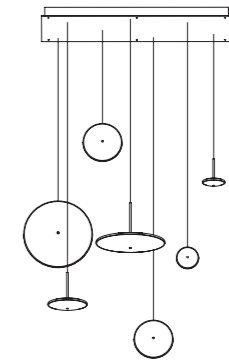

Drop 7

Single rectangular canopy
7 pendants
2.5m drop

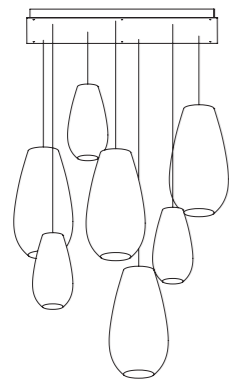

Disc 7

Single rectangular canopy
7 pendants
2.5m drop

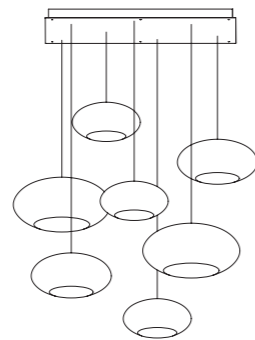

Bell 7

Single rectangular canopy
7 pendants
2.5m drop

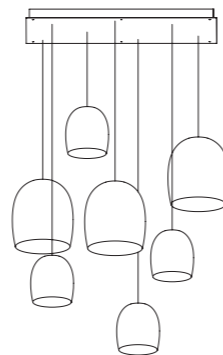

Pebble 7

Single rectangular canopy
7 pendants
2.5m drop

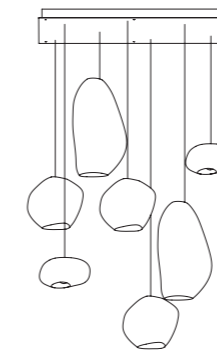

Roest 14

Single rectangular canopy
14 pendants
2.5m drop

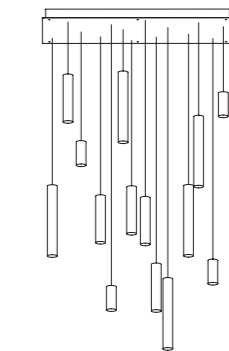

Cable-suspended

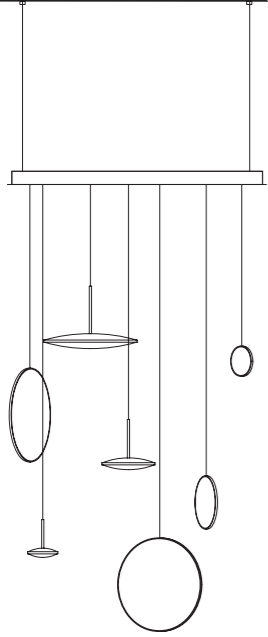

Flush-mounted

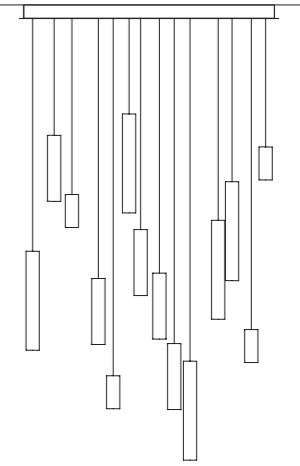

Architecture

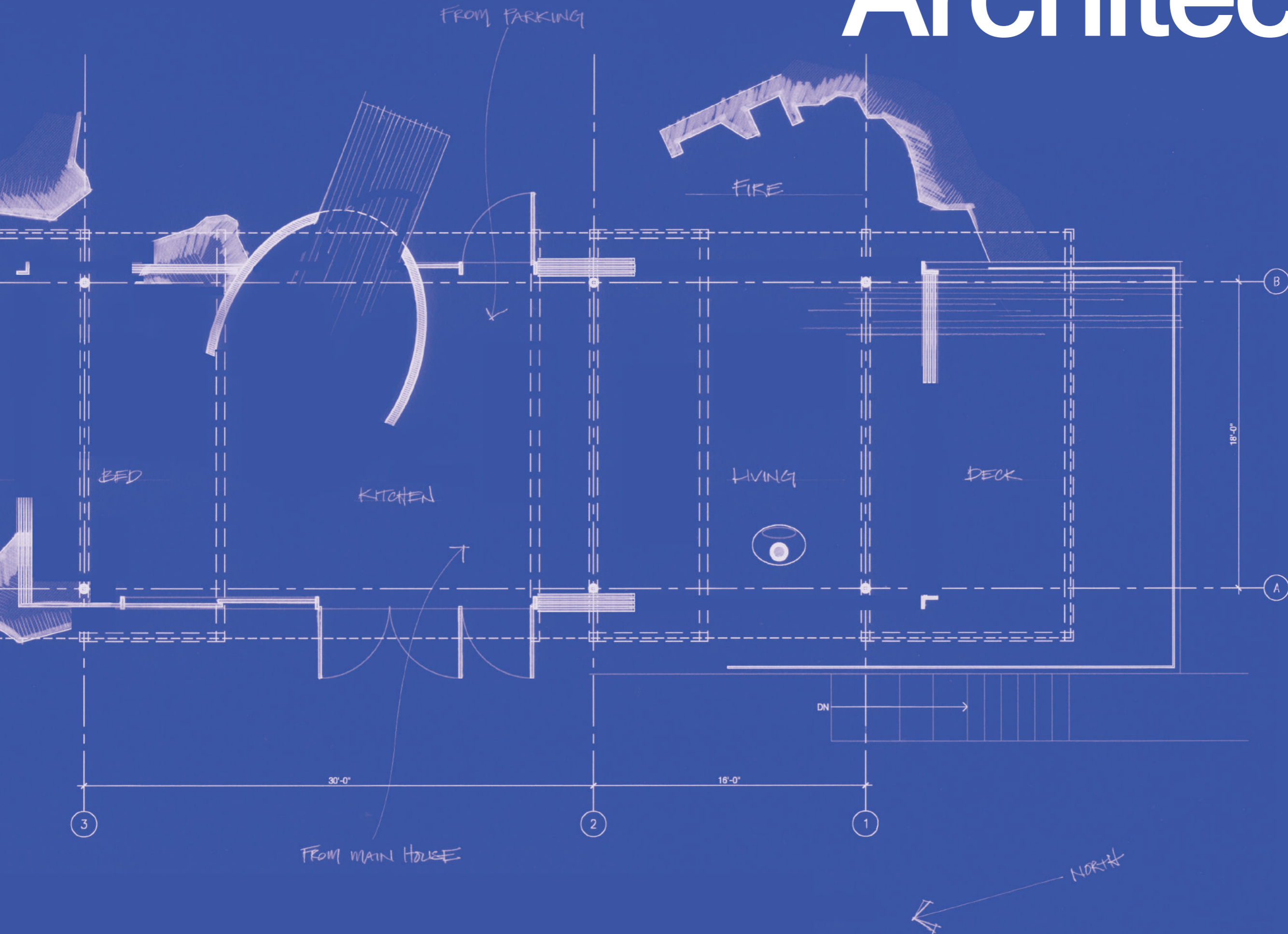

Garage





The distinction between lighting and architecture is, in a sense, a nonsensical one—we undeniably experience architecture via lighting, and lighting via architecture. Pushing this concept, Graypants framed its debut architectural project, The Garage, as a lantern—architecture as lighting.

Originally a dilapidated garage from the post world war II era, the project set out to update the structure's use as a residential cabin that preserved the intricacies and stories of the old construction. Contemporary elements have been skillfully mixed in with the old to give each piece a second life and in turn a renewed function in the space.

The aged wooden floor is oriented to bring the eye out towards the water, revealing hidden beds that fold out into seats. A folding glass wall lifts to extend the usable space of the cabin onto the adjacent pebbled patio that forms the base for the structure. By exposing the square frame wide flange that supports the cabin, and illuminating the member from within the web, the cabin seems to almost float above the ground.

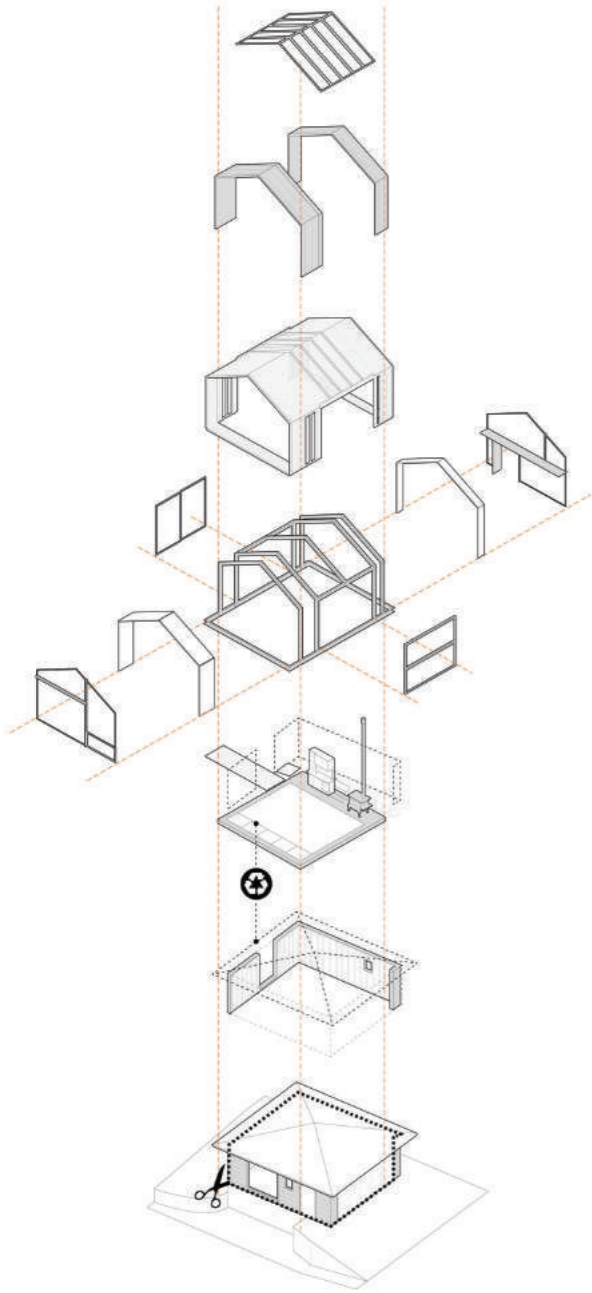



Halo



Halo is a restrained yet playful architectural project designed by Graypants on the shores of one of Washington State's San Juan Islands.. Strict parameters maintained by the zoning code were reimagined as opportunities to be creative and maximize the existing unique but small footprint.

Halo was initially conceived of as a home office, but as the client used the realized space, it gradually became a personal retreat. For the homeowner, this meant a slower pace and an openness to more reflection—Halo became an anchor for that transformation—a spiritual work space that is monastic without being religious.

An exploration of building-as-light, Halo blurs the lines between nature and structure. Honoring the site, the design responds directly to the landscape, creating a sense that Halo has been there for a long time. Surrounding landscaping welcomes and touches Halo, reaching up to the edges of the steel and glass. The small space attempts to maximize the experience—not of itself, but of the place: the nature, the light, the water.

Halo contains surprisingly few prominent fixtures in an attempt to allow the building itself to become the central fixture. A circular, domed skylight creates an anchoring center, offering connection to Halo's surroundings from five sides—bringing in natural light during the day, and sending a warm, haloed glow into the trees at night.

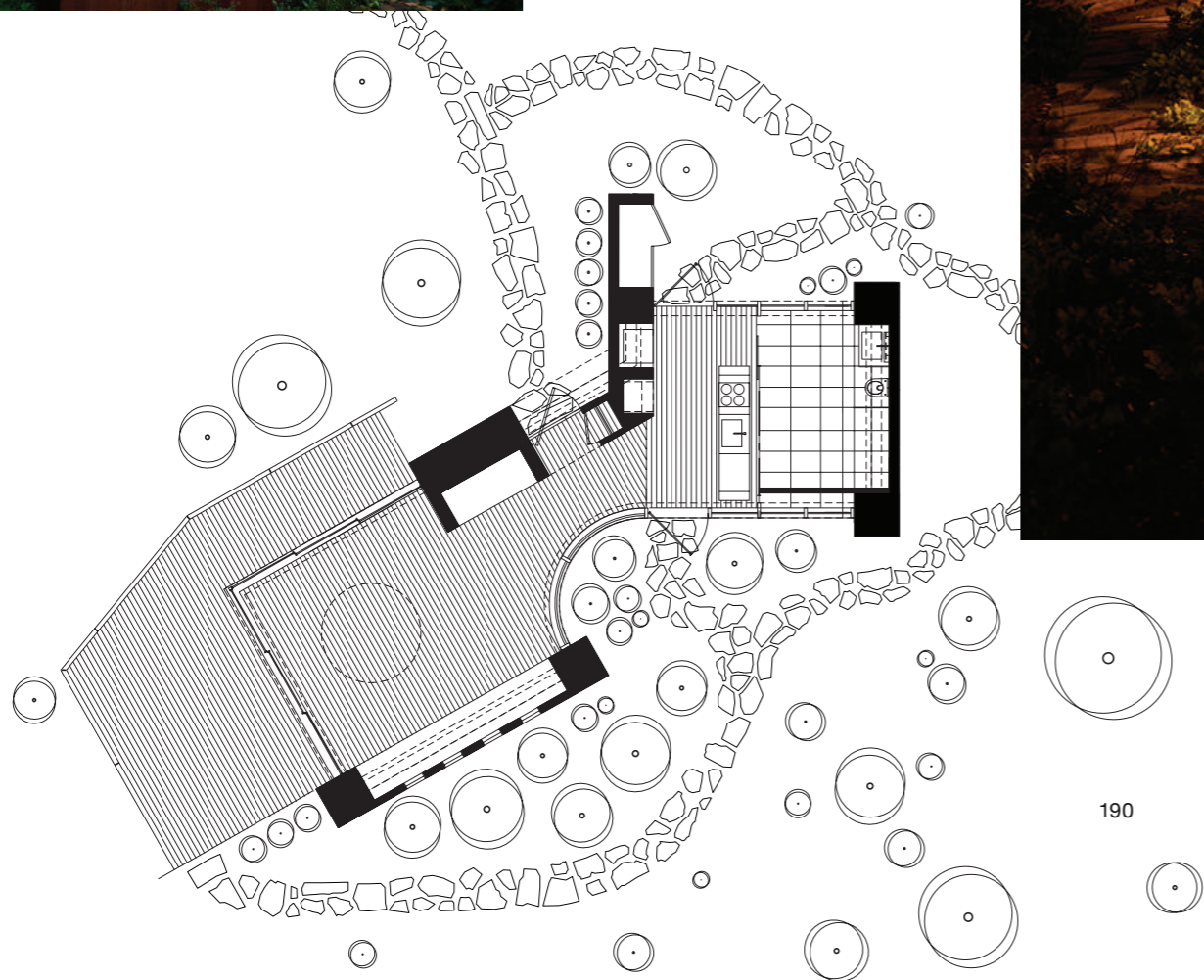

Tomo



The client named the restaurant Tomo after his grandmother, Tomoko, and the Japanese “tomodachi”, meaning ‘friend’. Friendship and familial connection is a throughline in how the restaurant approaches both its service and its place in a developing area south of Seattle.

Wood is a centerpiece of the space—referencing shou sugi ban, much of the interior wood has been stained a deep ebony. Oak shingles arranged like scales clad a wall running the length of the space, and contrast the strict geometry of the vertical ash slats that wrap the opposing walls. The mingling of wood throughout the space creates an understated, monochrome texture—the architecture aims to be demure and humble, letting the food be the center of the experience.

Nearly all of the lighting was directly integrated into the architectural elements—the wall panels, the bench seating, the bar shelves—the lighting is felt but not seen. The exception is an 80-foot linear fixture that traces the entire length of the restaurant.

Using local materials and manufacturing in nearly every aspect of the design—the craftsmanship, the wood—was intentional in bringing down the carbon footprint of the project.

Since opening, the restaurant has immediately begun outperforming their projections, with a booked out calendar bringing hundreds of people to the neighborhood every single evening, and a rolling waitlist topping a thousand eager diners.



